

# Manitowoc Cranes

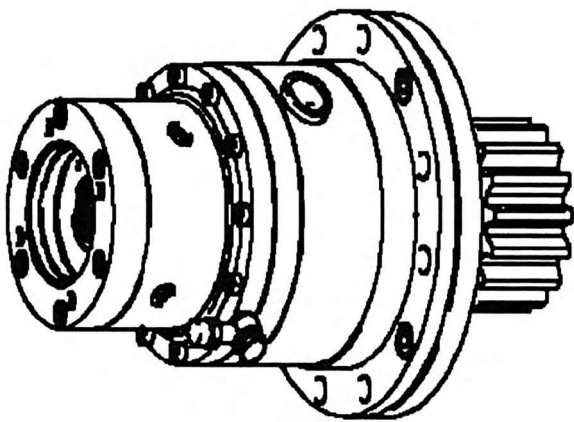
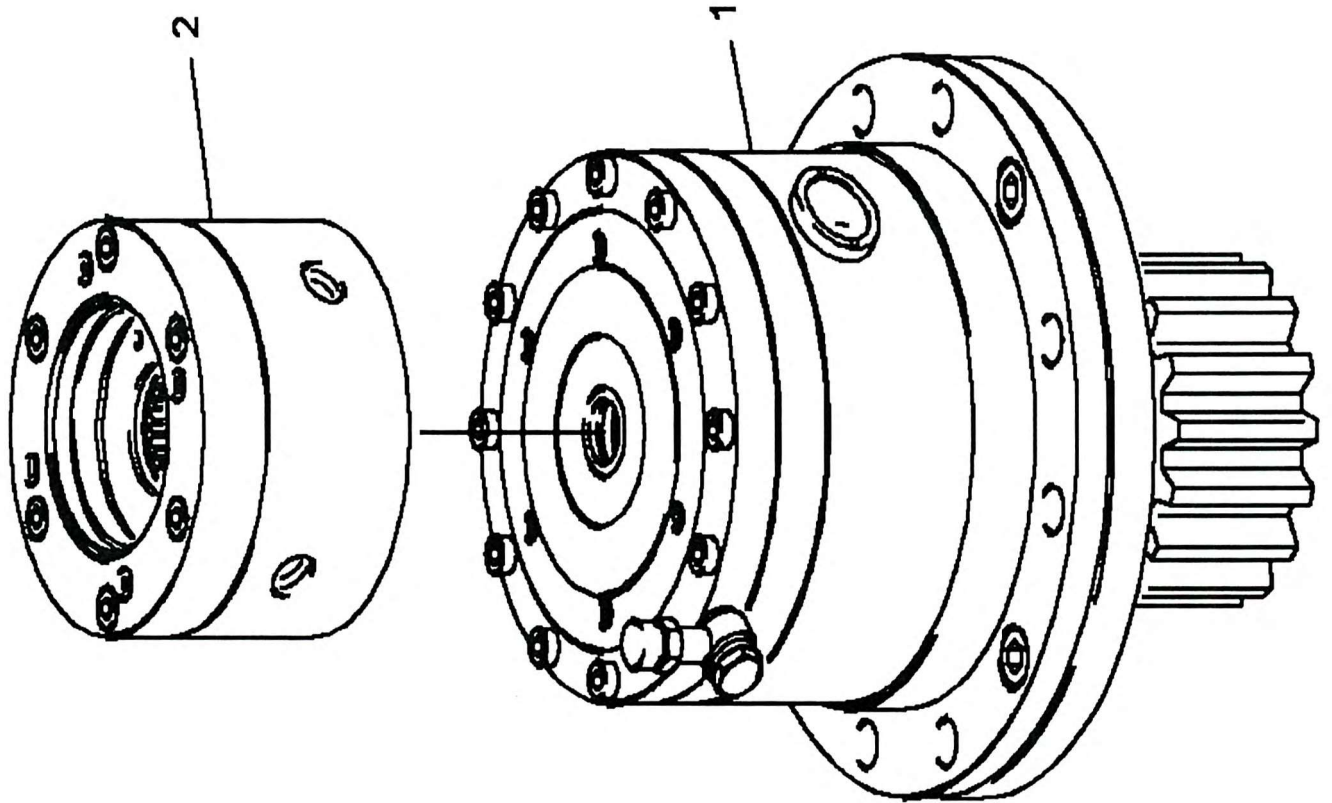

03010220

(SHEET 1 OF 1)

Page 216